

21-24 ROYAL ARCADE, CASTLE STREET, NORWICH, NR2 1NQ

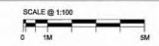

COVERS	
BASEMENT	0
GROUND FLOOR INTERNAL	96
GROUND FLOOR ARCADE EXTERNAL	14
GROUND FLOOR TOTAL	110
FIRST FLOOR	152
SECOND FLOOR	12
TOTAL COVERS	274
2ND FLOOR AREAS	
DINING	20.5M <sup>2</sup>
F.D.H	24.5M <sup>2</sup>
B.D.H	200.5M <sup>2</sup>
2ND FLOOR TOTAL	245.5M <sup>2</sup>

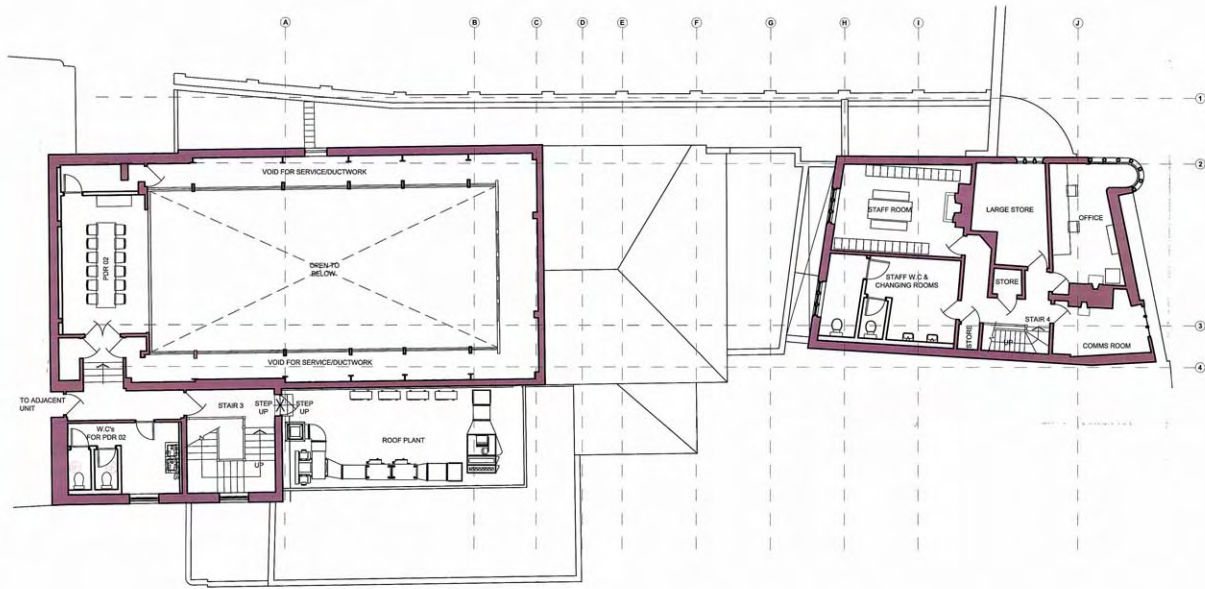

01 SECOND FLOOR PLAN  
1:100 @ A1

REVISIONS

Rev.	Date	Comment
I	06.06.11	FIRST ISSUE ISSUED FOR PLANNING APPLICATION
A	09.08.11	FIRST FLOOR COVERS REVISED ISSUED FOR PLANNING APPLICATION

10 AUG 2011

**REVISED**

PLANNING

- © MARTIN BRUDNIZKI DESIGN STUDIO LTD 2011
- NOTES
1. THE DRAWING SHOWS DESIGN INTENT ONLY. ALL DIMENSIONS TO BE CHECKED ON SITE PRIOR TO CONSTRUCTION OR PRODUCTION. CONSTRUCTION DETAILS TO BE CONFIRMED BY CONTRACTOR/MANUFACTURER BY SUBMITTING SHOP DRAWINGS FOR DESIGNER'S APPROVAL.
  2. DESIGN / DRAWING IS NOT TO BE SCALED FOR PRODUCTION AND CONSTRUCTION PURPOSES.
  3. ALL DISCREPANCIES AND OMISSIONS ON SITE MUST BE REPORTED TO DESIGNER FOR THEIR COMMENTS OR APPROVAL PRIOR TO COMMENCING WORK.
  4. ALL ELECTRICAL, LIGHTING, HVAC AND PLUMBING ISSUES TO BE REFERRED TO ENGINEER'S DRAWINGS PRIOR TO COMMENCEMENT OF WORKS.
  5. THE DESIGN IS SUBJECT TO APPROVAL BY STATUTORY AUTHORITIES AND ANY NECESSARY ALTERATIONS SHOULD BE MADE IF REQUIRED TO COMPLY WITH STATUTORY REQUIREMENTS.
  6. ALL DESIGN CONCEPTS AND DRAWINGS ARE THE PROPERTY OF MARTIN BRUDNIZKI AND ARE COVERED BY COPYRIGHT. NO REPRODUCTIONS, ADAPTATIONS AND/OR COPIES MAY BE MADE WITHOUT WRITTEN PERMISSION BY MARTIN BRUDNIZKI.

A1 Sheet

Project  
JAMIES ITALIAN NORWICH

Title  
SECOND FLOOR  
GENERAL ARRANGEMENT

Date  
06.06.11

Scale  
1:50

Project No  
32910

Drwg No  
PL-18

Rev.  
A

MARTIN BRUDNIZKI  
DESIGN STUDIO LTD  
Unit 1G Chelsea Reach  
79-89 Lots Road London SW10 0RN  
Tel +44 (0)20 7376 7555  
Fax +44 (0)20 7376 7444

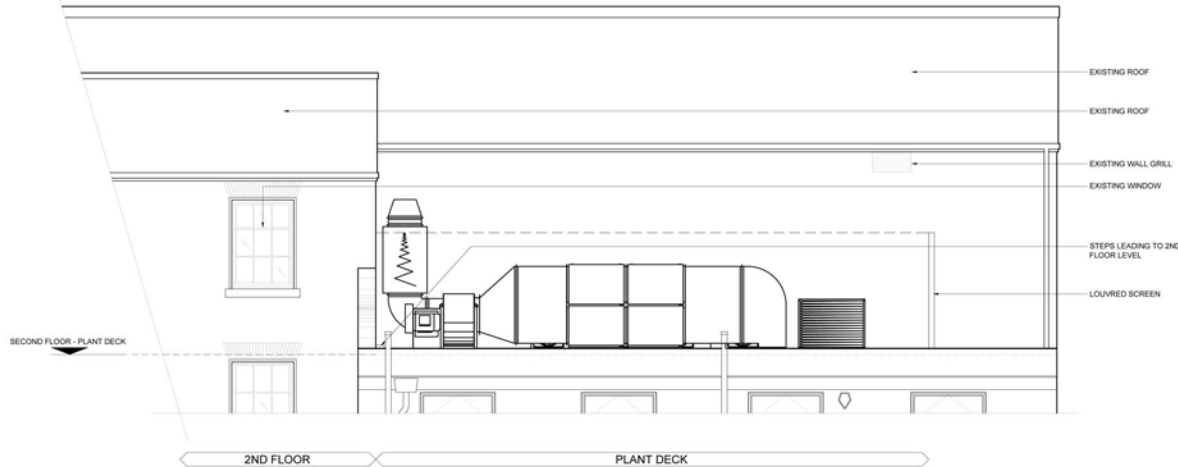

**01** PLANT DECK ELEVATION A  
1:50 @ A1

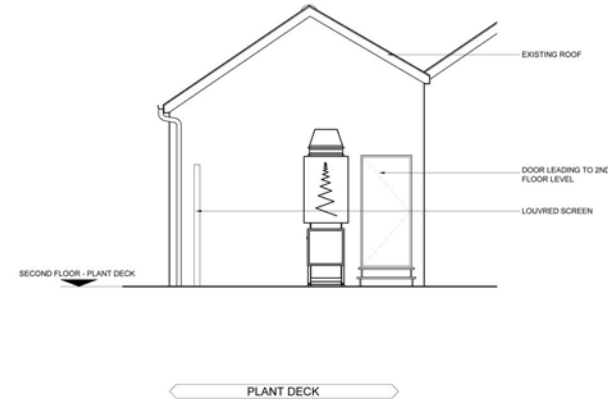

**02** PLANT DECK ELEVATION B  
1:50 @ A1

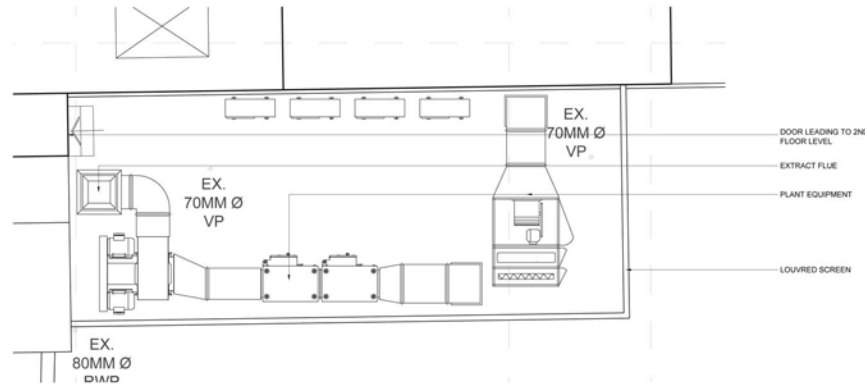

**03** PLANT DECK PLAN  
1:50 @ A1

NOTE: ALL DIMENSIONS NEED TO BE CONFIRMED ON SITE

REVISIONS

Rev.	Date	Comment
1	06.06.11	FIRST ISSUE ISSUED FOR PLANNING APPLICATION

PLANNING

© MARTIN BRUDNIZKI DESIGN STUDIO LTD 2011

NOTES

1. THE DRAWING SHOW DESIGN INTENT ONLY. ALL DIMENSIONS TO BE CHECKED ON SITE PRIOR TO CONSTRUCTION OR PRODUCTION. CONSTRUCTION DETAILS TO BE CONFIRMED BY CONTRACTOR MANUFACTURER BY SUBMITTING SHOP DRAWINGS FOR DESIGNER'S APPROVAL.
2. DESIGN / DRAWING IS NOT TO BE SCALED FOR PRODUCTION AND CONSTRUCTION PURPOSES
3. ALL DISCREPANCIES AND OMISSIONS ON SITE MUST BE REPORTED TO DESIGNER FOR THEIR COMMENTS OR APPROVAL PRIOR TO COMMENCING WORK.
4. ALL ELECTRICAL, LIGHTING, HVAC AND PLUMBING ISSUES TO BE REFERRED TO ENGINEER'S DRAWINGS PRIOR TO COMMENCEMENT OF WORKS.
5. THE DESIGN IS SUBJECT TO APPROVAL BY STATUTORY AUTHORITIES AND ANY NECESSARY ALTERATIONS SHOULD BE MADE IF REQUIRED TO COMPLY WITH STATUTORY REQUIREMENTS.
6. ALL DESIGN CONCEPTS AND DRAWINGS ARE THE PROPERTY OF MARTIN BRUDNIZKI AND ARE COVERED BY COPYRIGHT. NO REPRODUCTIONS, ADAPTATIONS AND/OR COPIES MAY BE MADE WITHOUT WRITTEN PERMISSION BY MARTIN BRUDNIZKI.

A1 Sheet

Project  
**JAMIE'S ITALIAN, NORWICH**  
Title  
**PLANT DECK ELEVATIONS**

Date  
06.06.11

Scale  
1:50

Project No  
32910

Drwg No  
PL-19

Rev.  
/

**MARTIN BRUDNIZKI**  
DESIGN STUDIO LTD  
Unit 1G Chelsea Reach  
79-89 Lots Road London SW10 0RN  
Tel +44 (0)20 7376 7555  
Fax +44 (0)20 7376 7444

1101231F J  
1101242L J

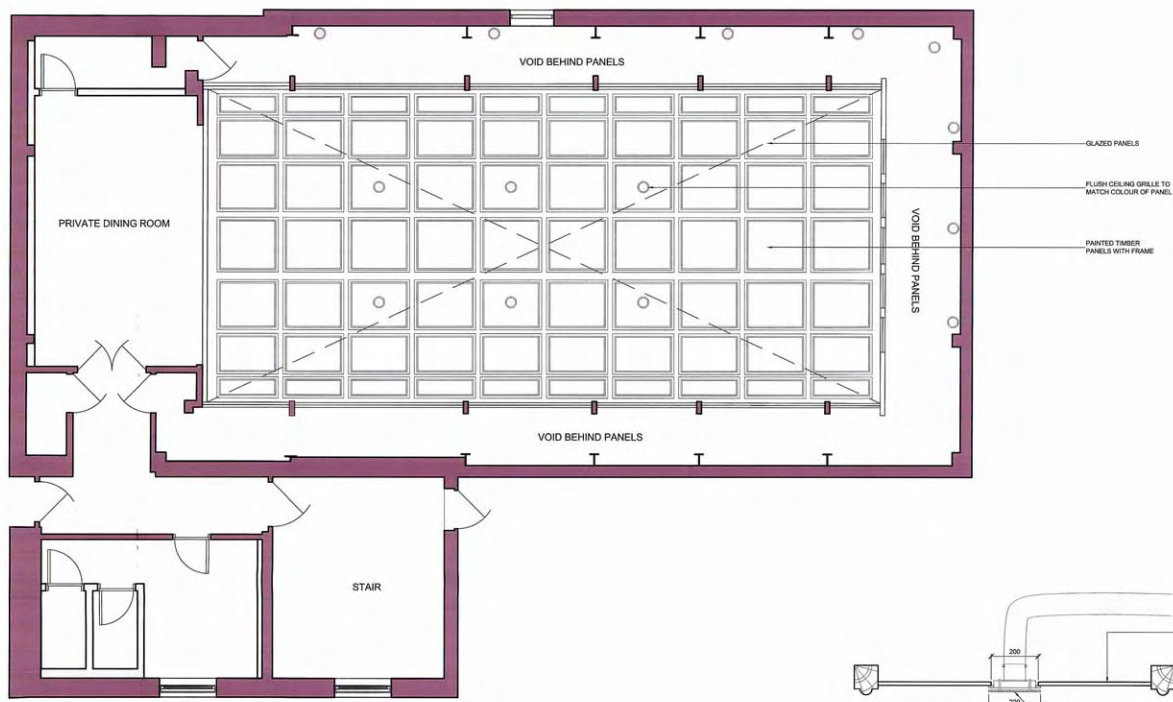

01 SECOND FLOOR ROOF PLAN  
1:50 @ A1

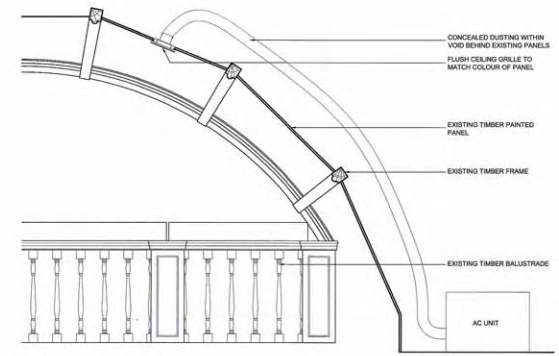

02 SECTION OF ROOF PANELS  
1:20 @ A1

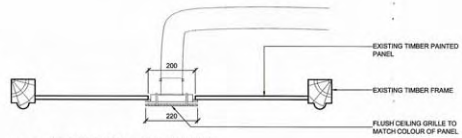

03 SECTION OF ROOF PANEL  
1:10 @ A1

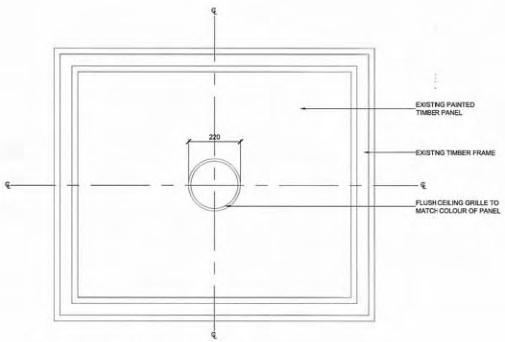

04 PLAN OF ROOF PANEL  
1:10 @ A1

REVISIONS		
Rev.	Date	Comment
1	09.08.11	FIRST ISSUE ISSUED FOR PLANNING APPLICATION
10 AUG 2011		
<b>REVISED</b>		
<b>PLANNING</b>		

- © MARTIN BRUDNIZKI DESIGN STUDIO LTD 2011
- NOTES**
1. THE DRAWING SHOW DESIGN INTENT ONLY. ALL DIMENSIONS TO BE CHECKED ON SITE PRIOR TO CONSTRUCTION OR PRODUCTION. CONSTRUCTION DETAILS TO BE CONFIRMED BY CONTRACTOR MANUFACTURER BY SUBMITTING SHOP DRAWINGS FOR DESIGNER'S APPROVAL.
  2. DESIGN / DRAWING IS NOT TO BE SCALED FOR PRODUCTION AND CONSTRUCTION PURPOSES.
  3. ALL DISCREPANCIES AND OMISSIONS ON SITE MUST BE REPORTED TO DESIGNER FOR THEIR COMMENTS OR APPROVAL PRIOR TO COMMENCEMENT WORK.
  4. ALL ELECTRICAL, LIGHTING, HVAC AND PLUMBING ISSUES TO BE REFERRED TO ENGINEER'S DRAWINGS PRIOR TO COMMENCEMENT OF WORK.
  5. THE DESIGNER ARE SUBJECT TO APPROVAL BY STATUTORY AUTHORITIES AND ANY NECESSARY ALTERATIONS SHOULD BE MADE IF REQUIRED TO COMPLY WITH STATUTORY REQUIREMENTS.
  6. ALL DESIGN CONCEPTS AND DRAWINGS ARE THE PROPERTY OF MARTIN BRUDNIZKI AND ARE COVERED BY COPYRIGHT. NO REPRODUCTIONS, ADAPTATIONS AND/OR COPIES MAY BE MADE WITHOUT WRITTEN PERMISSION BY MARTIN BRUDNIZKI.

A1 Sheet

**Project**  
JAMIE'S ITALIAN, NORWICH

**Title**  
ROOF PLAN & GRILLE DETAILS

**Date**      **Scale**  
09.08.11    AS SHOWN

**Project No**  
32910

**Drwg No**                      **Rev.**  
PL-21                            /

**MARTIN BRUDNIZKI**  
DESIGN STUDIO LTD  
Unit 1G Chelsea Reach  
79-89 Lots Road London SW10 0RN  
Tel +44 (0)20 7376 7555  
Fax +44 (0)20 7376 7444



B 04-08-11 DH New architects layout with amendments to scheme following comments.  
 A 13-04-11 DH New architects layout.

No.	Date	Rev	By	Revision Description

Client:



Project :  
 Jamie's Italian,  
 No 21-24 Royal Arcade,  
 Castle Street,  
 Norwich,  
 NR2 1NQ

Drawing Title :  
 Ventilation Layout,  
 Basement

Drawing No.: **JAM10-01** Rev: **B**

Scale: @A1 = 1:50 @A3 = 1:100  
 Drawn By: DAN Date: 30-03-11

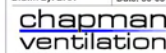

Unit 2, Little Mundeley,  
 Welwyn Garden City,  
 Hertfordshire AL7 1TB  
 Tel: 01937 372888 Fax: 01937 320001  
 E-mail: info@chapmanventilation.co.uk  
 Web: www.chapmanventilation.co.uk

Copyright of this drawing resides with Chapman Ventilation Limited



B	04-09-11	DH	New architects layout.
A	13-04-11	DH	New architects layout.
No.	Date	Rev	Revision Description

Client: **Jamie's ITALIAN**

Project:  
 Jamie's Italian,  
 No 21-24 Royal Arcade,  
 Castle Street,  
 Norwich,  
 NR2 1NQ

Drawing Title:  
**Ventilation Layout,  
 Ground Floor**

Drawing No.:	Rev:
JAM10-02	B
Scale: @A1 = 1:50 @A3 = 1:100	
Drawn By: DAN	Date: 30-03-11

**chapman ventilation**  
 Unit 2 Little Marable  
 Welwyn Garden City  
 Hertfordshire AL7 1EJ  
 Tel: 01977 372808 Fax: 01977 320001  
 E-mail: info@chapmanventilation.co.uk  
 Web: www.chapmanventilation.co.uk  
 Copyright of this drawing resides with Chapman Ventilation Limited

AC drops from AC Units above into grilles.

Underfloor heating by others

Underfloor heating by others

Supply Air Fan (5.0kg) with inline filters/Electric heater battery.

Toilet/General Extract fan (5.0kg)

Toilet extract wall fan (5.0kg)

Wall mounted AC unit (12kg)

- C 22-08-11 DH New architects layout with amendments to scheme
  - B 04-06-11 DH New architects layout with amendments to scheme following comments.
  - A 13-04-11 DH New architects layout.
- No. Date Rev By Revision Description
- Client:

**Jamie's ITALIAN**

Project:  
**Jamie's Italian,  
 No 21-24 Royal Arcade,  
 Castle Street,  
 Norwich,  
 NR2 1NQ**

Drawing Title:  
**Ventilation Layout,  
 First Floor**

Drawing No.: **JAM10-03** Rev: **C**  
 Scale: @A1 = 1:50 @A3 = 1:100  
 Drawn By: DAN Date: 30-03-11

**chapman ventilation**  
 Unit 2 Little Marable  
 Welwyn Garden City  
 Hertfordshire AL7 1EJ  
 Tel: 01707 373808 Fax: 01707 320001  
 E-mail: info@chapmanventilation.co.uk  
 Web: www.chapmanventilation.co.uk

Copyright of this drawing resides with Chapman Ventilation Limited

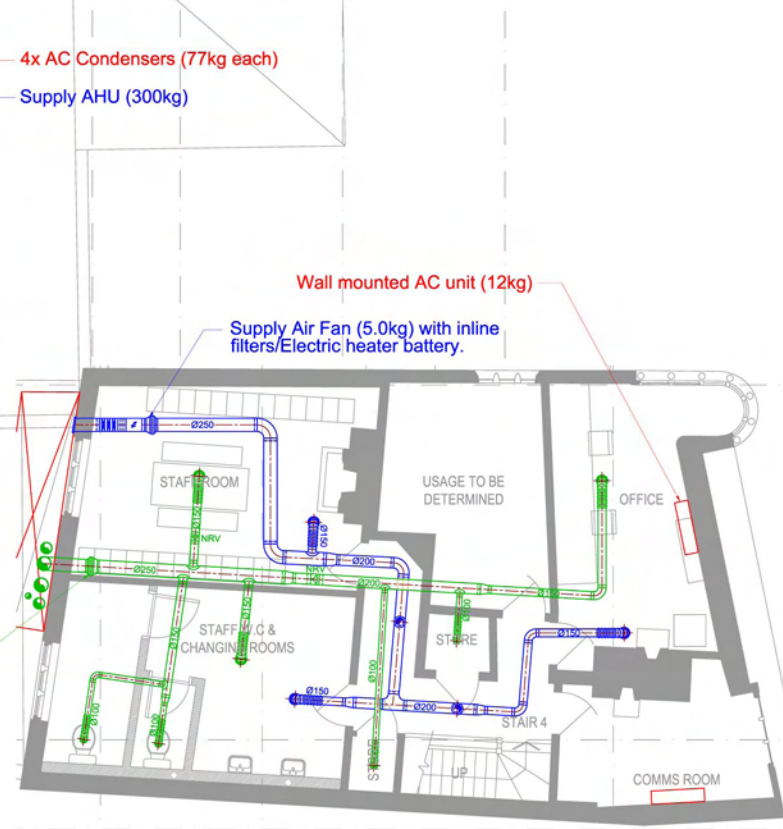
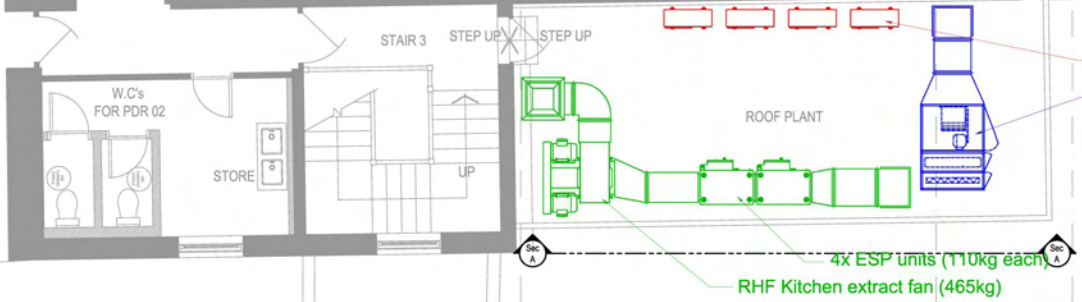
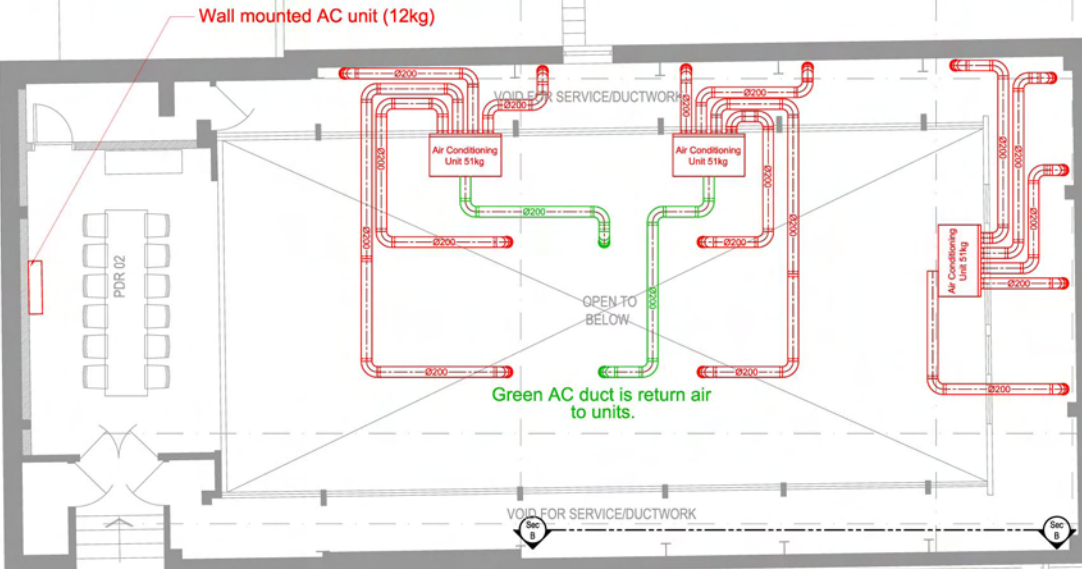

C	04-06-11	DH	New architects layout with amendments to scheme following comments.
B	05-05-11	DH	Changes to the kitchen extract discharge.
A	13-04-11	DH	New architects layout.
No.	Date	Rev. By	Revision Description

Client:  
**Jamie's ITALIAN**  
 Project:  
 Jamie's Italian,  
 No 21-24 Royal Arcade,  
 Castle Street,  
 Norwich,  
 NR2 1NQ

Drawing Title:  
**Ventilation Layout,  
 Second Floor,  
 Option 1**

Drawing No.: **JAM10-04** Rev: **C**  
 Scale: @A1 = 1:50 @A3 = 1:100  
 Drawn By: DAN Date: 30-03-11

**chapman ventilation**  
 Unit 2 Little Marable  
 Welwyn Garden City  
 Hertfordshire AL7 1ER  
 Tel: 01763 373888 Fax: 01763 320001  
 E-mail: info@chapmanventilation.co.uk  
 Web: www.chapmanventilation.co.uk  
 Copyright of this drawing resides with Chapman Ventilation Limited

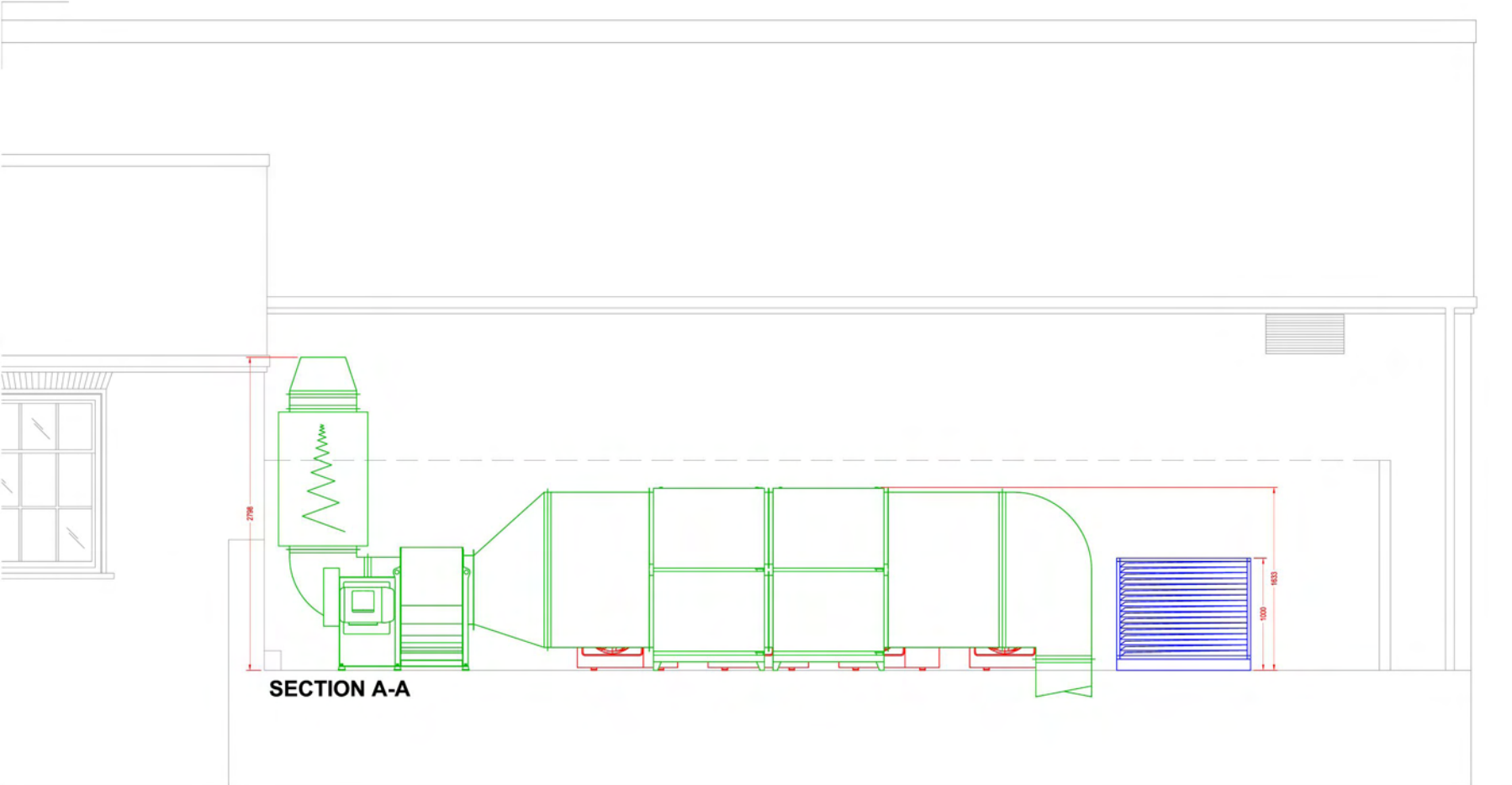

**SECTION A-A**

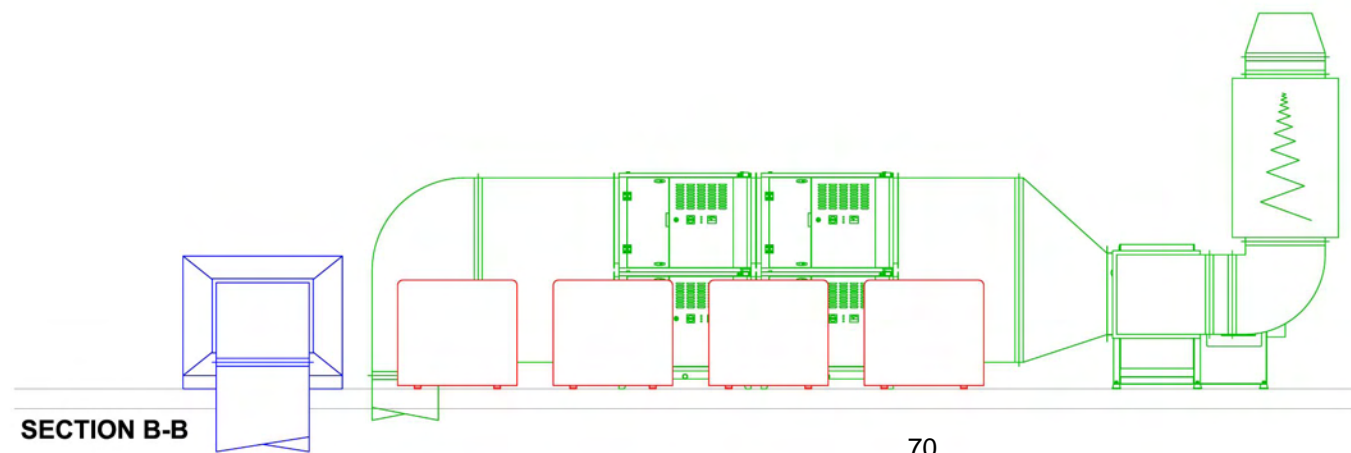

**SECTION B-B**

70

No.	Date	Rev. By	Revision Description
A	05-05-11	DH	Changes to the extract discharge.

Client: **Jamie's ITALIAN**

Project:  
 Jamie's Italian,  
 No 21-24 Royal Arcade,  
 Castle Street,  
 Norwich,  
 NR2 1NQ

Drawing Title:  
**Plant Area Sections**

Drawing No.:	Rev:
<b>JAM10-05</b>	<b>A</b>
Scale: @A1 = 1:20 @A3 = 1:40	
Drawn By: DAN	Date: 26-04-11

**chapman ventilation**  
 Unit 2, Little Mundeley,  
 Welwyn Garden City,  
 Hertfordshire AL7 1EJ  
 Tel: 01707 372808 Fax: 01707 320021  
 Email: info@chapmanventilation.co.uk  
 Web: www.chapmanventilation.co.uk  
 Copyright of this drawing resides with Chapman Ventilation Limited





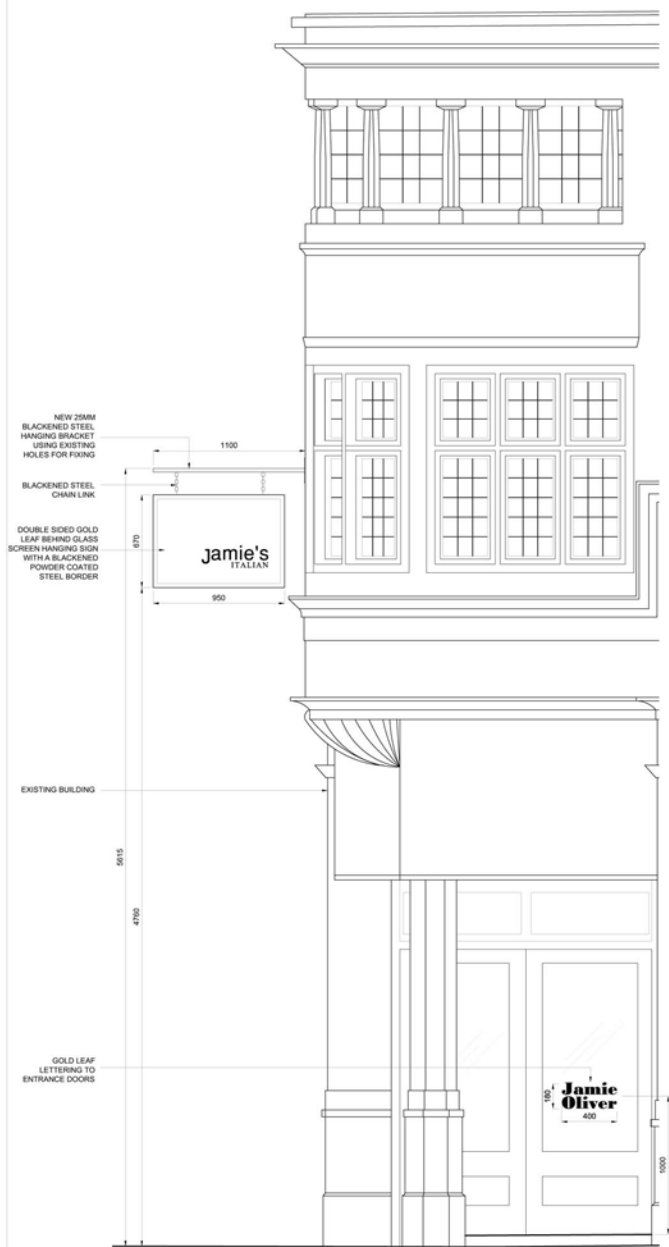

**01** HANGING SIGN - NORTH ELEVATION  
1:20 @ A1



**03** GOLD LEAF LETTERING TO DOOR GLAZING  
1:20 @ A1

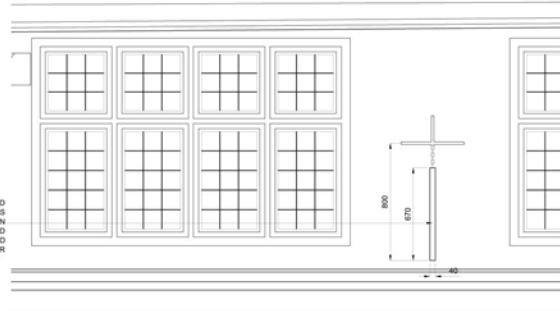

**02** HANGING SIGN & WINDOW SIGN - EAST ELEVATION  
1:20 @ A1



**04** SIGNAGE TO ARCADE ELEVATION  
1:20 @ A1

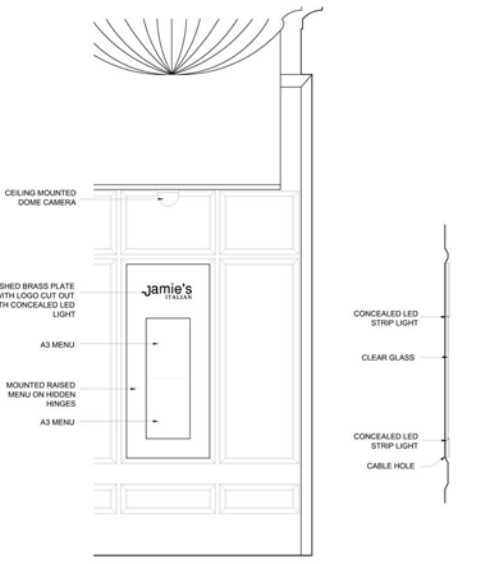

**05** MENU BOX ELEVATION  
1:10 @ A1

**06** MENU SECTION  
1:10 @ A1

Rev.	Date	Comment
1	06.06.11	FIRST ISSUE ISSUED FOR PLANNING APPLICATION

**PLANNING**

C MARTIN BRUDNIZKI DESIGN STUDIO LTD 2010

**NOTES**

1. THE DRAWING SHOW DESIGN INTENT ONLY. ALL DIMENSIONS TO BE CHECKED ON SITE PRIOR TO CONSTRUCTION OR PRODUCTION. CONSTRUCTION DETAILS TO BE CONFIRMED BY CONTRACTOR MANUFACTURER BY SUBMITTING SHOP DRAWINGS FOR DESIGNER'S APPROVAL.
2. DESIGN / DRAWING IS NOT TO BE SCALED FOR PRODUCTION AND CONSTRUCTION PURPOSES.
3. ALL DISCREPANCIES AND OMISSIONS ON SITE MUST BE REPORTED TO DESIGNER FOR THEIR COMMENTS OR APPROVAL PRIOR TO COMMENCING WORK.
4. ALL ELECTRICAL, LIGHTING, HVAC AND PLUMBING ISSUES TO BE REFERRED TO ENGINEER'S DRAWINGS PRIOR TO COMMENCEMENT OF WORKS.
5. THE DESIGNS ARE SUBJECT TO APPROVAL BY STATUTORY AUTHORITIES AND ANY NECESSARY ALTERATIONS SHOULD BE MADE IF REQUIRED TO COMPLY WITH STATUTORY REQUIREMENTS.
6. ALL DESIGN CONCEPTS AND DRAWINGS ARE THE PROPERTY OF MARTIN BRUDNIZKI AND ARE COVERED BY COPYRIGHT. NO REPRODUCTIONS, ADAPTATIONS AND/OR COPIES MAY BE MADE WITHOUT WRITTEN PERMISSION BY MARTIN BRUDNIZKI.

A1 Sheet

**Project**  
JAMIE'S ITALIAN, NORWICH  
**Title**  
SIGNAGE & MENU BOX

**Date** 06.06.11  
**Scale** AS SHOWN

**Project No**  
32910

**Drwg No** PL-14  
**Rev.** /

**MARTIN BRUDNIZKI**  
DESIGN STUDIO LTD  
Unit 1G Chelsea Reach  
79-89 Lots Road London SW10 0RN  
Tel +44 (0)20 7376 7555  
Fax +44 (0)20 7376 7444